



**PAKOLE**

# USER'S MANUAL

**FOR INDUSTRIAL USE ONLY**

**MODULATION THERMOSTAT WITH EXTERNAL TEMPERATURE  
SENSOR FOR GTV FORCED AIR HEATERS**

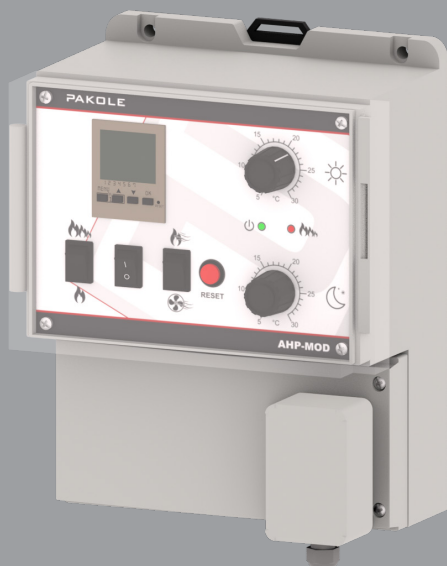

Regulator type:  
**AHP-MOD**

AHPMOD\_009\_029\_011\_220826\_V004\_EN

[www.pakole.com](http://www.pakole.com)

**EN**

# Table of Contents

<b>1. SAFETY INFORMATION.....</b>	<b>2</b>
<b>2. GENERAL INFORMATION.....</b>	<b>3</b>
<b>3. DELIVERY, UNPACKING, HANDLING .....</b>	<b>3</b>
<b>4. OPERATION PRINCIPLE.....</b>	<b>4</b>
<b>5. APPLIANCE PLACEMENT .....</b>	<b>5</b>
Temperature regulator (front view) .....	5
Temperature regulator (rear view).....	5
Appliance placement.....	6
<b>6. ELECTRICAL CONNECTION .....</b>	<b>7</b>
<b>7. MAINTENANCE.....</b>	<b>9</b>
<b>8. TECHNICAL DATA.....</b>	<b>9</b>
<b>9. TIME SWITCH PROGRAMMING: PERRY 110 1081 4 BUTTONS ..</b>	<b>10</b>
Important informations about the time switches.....	16
<b>10. WARRANTY AND SERVICES .....</b>	<b>17</b>

## 1. SAFETY INFORMATION



**ATTENTION!** Read and understand this user's manual before assembling, starting, or servicing the device. The improper connection or usage can cause serious damages! Keep this manual in a safe place in order to obtain information in case of incidental problems.



**ATTENTION!** If the electric cable is damaged, it must be changed by a qualified service person.



**ATTENTION!** These regulators have been developed for devices manufactured and distributed by PAKOLE Trade Ltd., therefore they cannot be installed in other devices due to their different technical properties.

## 2. GENERAL INFORMATION

The AHP-MOD type temperature regulator is suitable for controlling a GTV type forced convection air heater or controlling a system constructed from these devices for heating of rooms.



## 3. DELIVERY, UNPACKING, HANDLING

The regulator is delivered in corrugated cardboard box.  
The process of unpacking the device:

- Remove the corrugated paper box and the cover foil from the device.
- Check that the delivered package contains all the accessories:
  - 1 pc. Temperature regulator
  - 3 pcs. PG 11 sealing bush
  - 1 pc. Temperature sensor
  - 1 pc. User's manual
- Check the device for transport damage.
- If you notice that the regulator is damaged, inform our retailer immediately from whom you purchased the device!

## 4. OPERATION PRINCIPLE

The **AHP-MOD** type modulation temperature regulator implements stepless power control of the heaters installed in the room.

The temperature sensor provides the reference signal required for control. Among them a digital programmable timer switches. The two potentiometers on the front of the controller allow you to set the desired day and night temperatures separately.

After connecting to the electrical network, the regulator immediately starts controlling the output according to the given setting values. There are green and red illuminated LEDs on the front panel. Green indicates that the device is energized. A steady red light indicates 100% operation, the LED flashes to indicate controlled (Modulation) mode. Each heating start starts at 100% mode for 60s, during which time the red LED can flash and operate continuously.



**ATTENTION! Switching the regulator's switch to the „0” position does not free from voltage either the temperature regulator or the GTV type heater/ system of heaters! The regulator can be de-energized by disconnecting the connector on the device.**

Use the rotary knobs („day / night”) on the controller to set the desired room temperature value. The regulator switches the air heater(s) on and off based on the air temperature.

On the left side of the front panel, there is a two-position modulation mode selector switch that operates in modulation mode in the upper state and operates at 100% power until the temperature is reached in the lower state.

On the front panel there is a two-way switch, which means in the upper position „1” as operation mode and in the lower position 0” as system turn off.

On the left side of the front panel there is a two-way mode selector switch. In its upper position it is in „Heating” (Winter mode), in the lower position, „Ventilation” (Summer) mode.

- Below the set temperature in heating mode, the temperature regulator starts the air heater or a system of heaters and then switches off as soon as the air temperature reaches the set temperature.
- In Ventilation Mode, below the set temperature, the regulator stops the ventilation and then restarts if the temperature rises.

There is also placed a red „RESET” button on the front panel of the **AHP-MOD** temperature regulator. If the GTV-type heater or the system of heaters are locked for some reason (ignition failure, gas shortage, etc.) the button is lighting. By pushing, it release the interlock.



**Attention! The set temperature is for information only. There may be a difference between the set and the measured temperature.**

# 5. APPLIANCE PLACEMENT

## TEMPERATURE REGULATOR (FRONT VIEW)

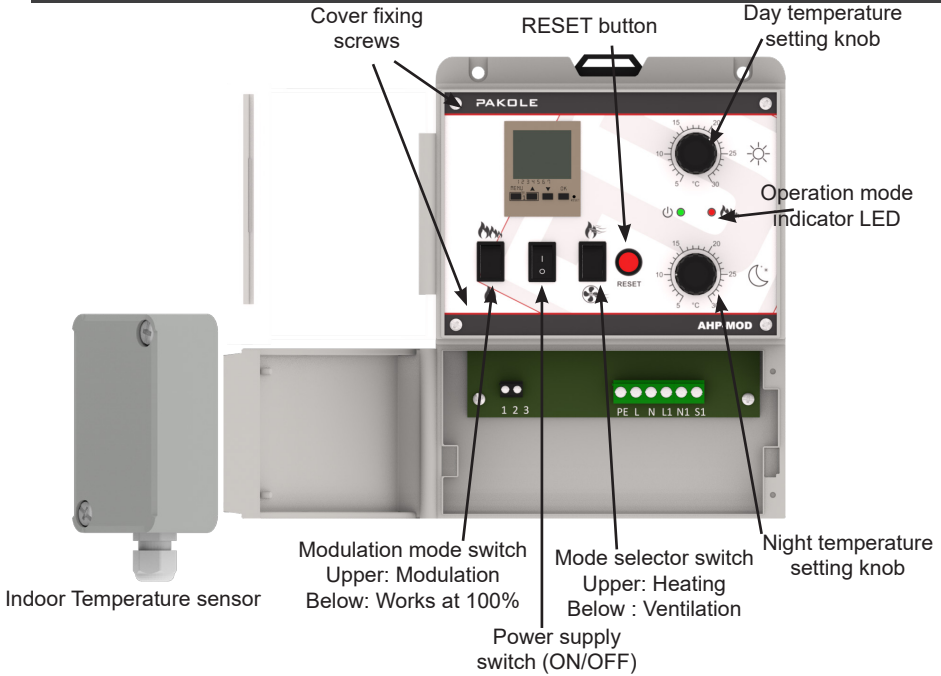

1/a. fig: Front view of the temperature regulator

## TEMPERATURE REGULATOR (REAR VIEW)

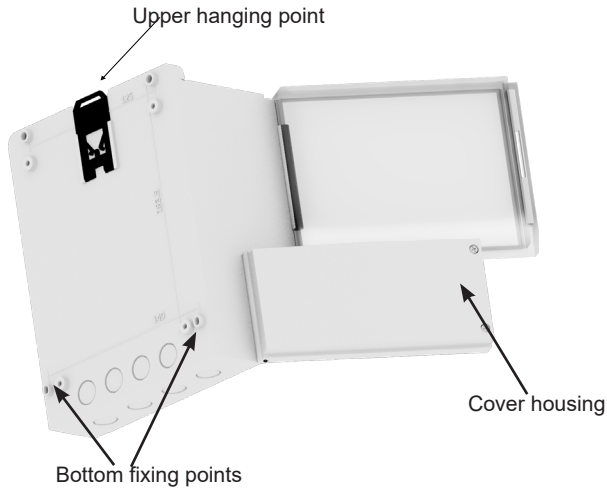

1/b. fig: Rear view of the temperature regulator

## APPLIANCE PLACEMENT

After unpacking the temperature regulator, the boreholes for mounting the device are accessible when opening or removing the cover on the bottom of the controller.

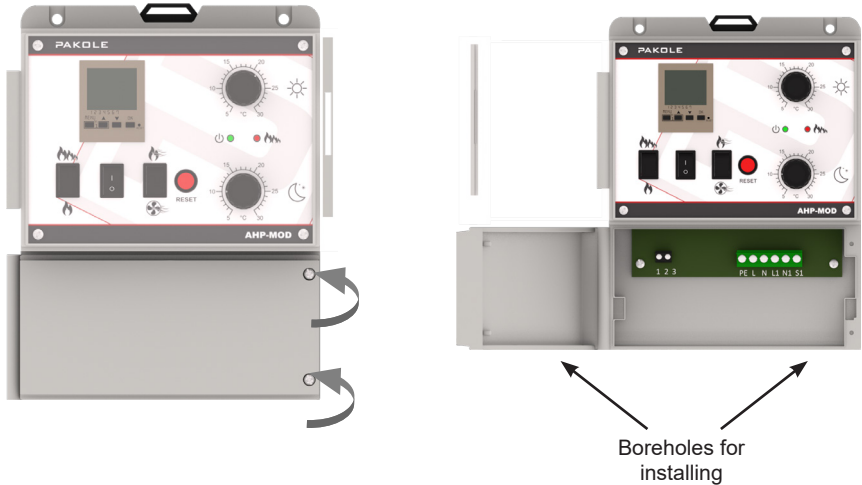

2. fig: Fixing points of the temperature regulator

In the room, the temperature regulator has to be placed at a height of 1.5 meter so it is protected from any radiation or other heat source.

In case of using radiant heaters the outdoor temperature sensor has to be placed at a height of 1.8-2 meter.



**All installation, connection and removal of the box lid must only be carried out when it is devoid of voltage!**

## 6. ELECTRICAL CONNECTION



**ATTENTION! Improper connection of the control unit can lead to permanent damage!**

Under the lid there is a screw terminal for connecting the regulator. The high voltage connectors has to be connected with an MT 3x0.75 ... 1.5, 400V operating voltage cable. The regulator has reinforced insulation, therefore it does not contain a protective earth connector, the regulator cannot be connected to a protective earth!

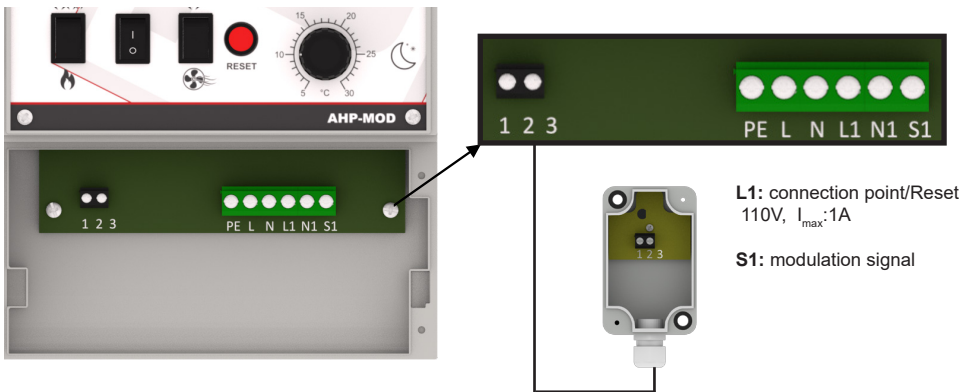

3. fig: Connection points of the temperature regulator (terminal strip)

It provides a relay control signal from the L1 connection point of the temperature regulator to the **GTV** type heater or to the system made of this heaters according to the operating mode set on the controller.

When connecting the power supply connection points (L, N) of the regulator, make sure that the neutral wire is connected to the connection point „N” and that the phase wire is connected to the connection point „L”

**S1 - modulation zero:** this provides the modulation control of the device depending on the temperature.

*Only with this connection can be ensured that the GTV-type device works properly.*



**ATTENTION! Switching the regulator's switch to the „0” position does not free from voltage either the temperature regulator or the heater! The regulator can be de-energized by disconnecting the connector on the device.**



**The regulator must be connected to the main electrical system with a two-pole isolating switch!**

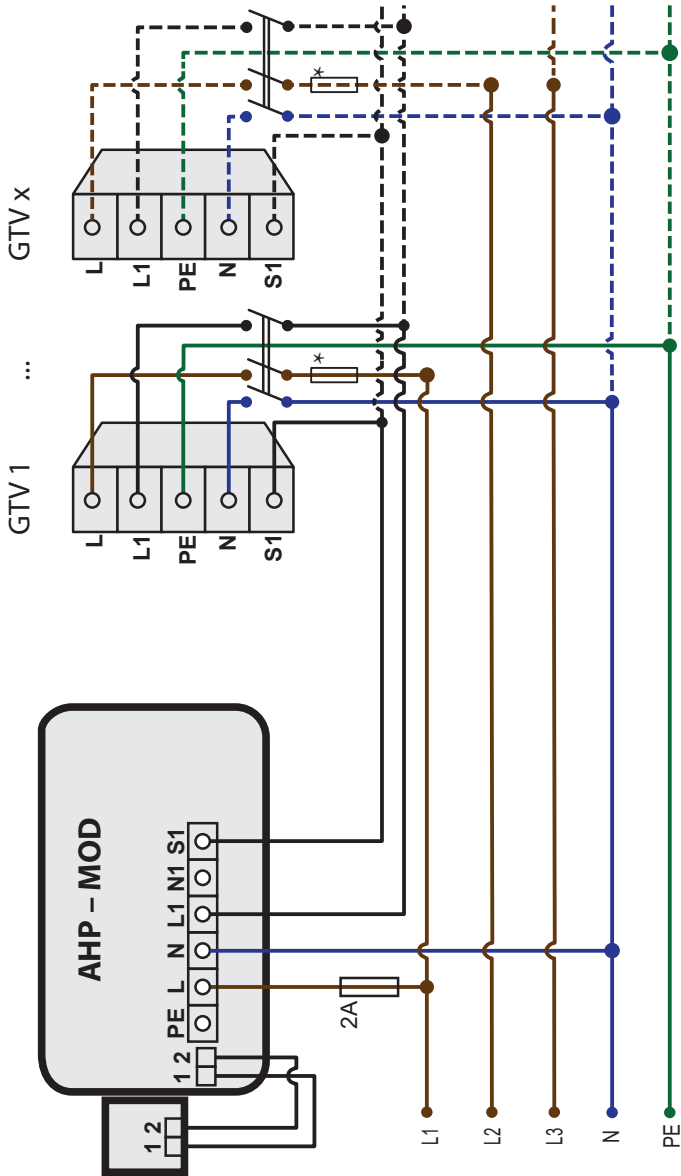

\* Fuse values

20-48 kW	5 A
48-87 kW	13 A
87-107 kW	16 A

5. fig: Wiring of the temperature regulator to the electrical

## 7. MAINTENANCE

---

The temperature regulator does not require maintenance when the set is used functionally. In case of any failure the repairing can be fulfilled only by specialist or professional service!

## 8. TECHNICAL DATA

---

Power supply:	230V / 50 Hz P <sub>max</sub> 1VA
Output:	Mode connected by L1 relay contact: 110V 1A
Control interval:	nature of value-based regulation
Setting value:	2 x +5...+30°C
Protection:	IP 54
Other data:	
House:	plastic
Connection:	through a gland to the screwed connecting strap
Insulation:	II. class
Enclosure size:	220x180x135 mm
Sensor:	NTC controller in separate housing
Sensor enclosure size:	40x30x85 mm

# 9. TIME SWITCH PROGRAMMING: PERRY 110 1081 4 BUTTONS

## 1. DISPLAY

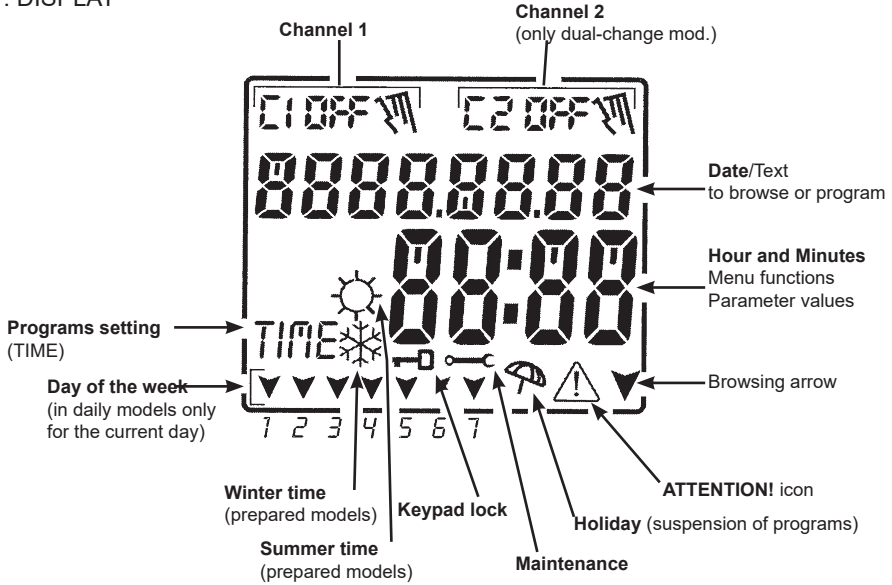

## 2. KEYS

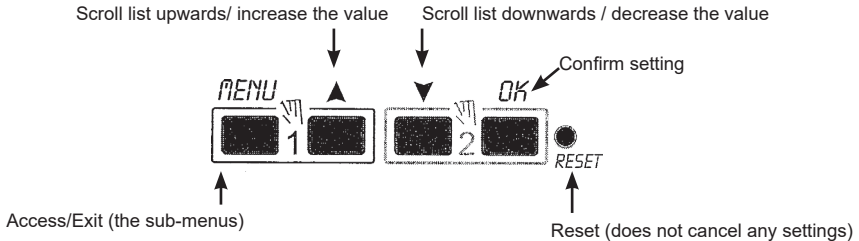

FUNCTION	PRESS THE KEY COMBINATION
Lock/unlock keys (  )	2 seconds
Access the <Manual> menu directly to enable/disable the temporary or permanent override.	for channel 1      for channel 2
Immediate exit from the menu or sub-menu	6 sec. until the main screen appears
In the Programs menu access the first free program that is to be set.	2 seconds
In the Programs menu, quickly deletes the selected program	press simultaneously for at least 6 seconds

### 3. FIRST START-UP

**IMPORTANT:** when programming, the settings made with the ↑↓ keys must be confirmed by pressing the **OK** key, and when **OKAY** appears on the display for a few seconds, it indicates that the data have been entered correctly in the permanent memory. Otherwise, after 2 minutes ( 10 minutes for <program> and <hour counter> settings), the digital switch returns to the „Normal operation“ main screen and the partial changes will not be saved.



Press the ▲ key or ▼ pulse key to increase/decrease per unit and keep pressed to increase/decrease rapidly.

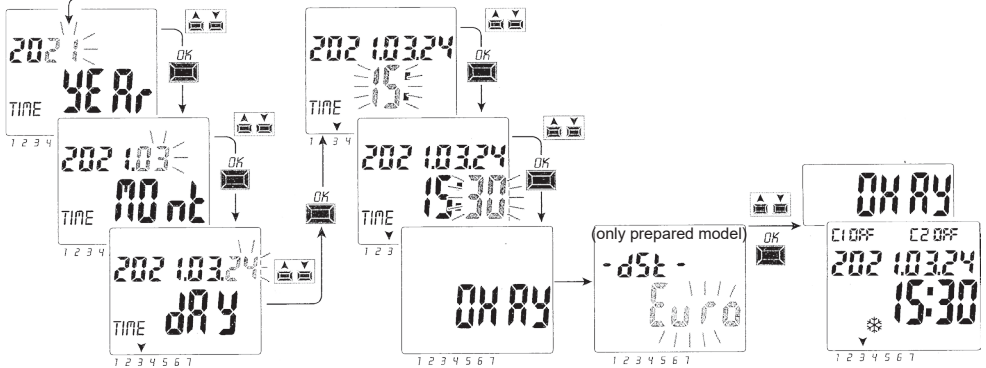

Set the summer or winter time. Select with the ↑↓ keys between EURO – FREE (must be programmed) – NONE and confirm with **OK**.

Possible selections on the display	Summer changeover +1h	Winter changeover -1h
EURO (Central Europe UTC+1)	Last Sunday in March	Last Sunday in October
FREE	Month/Week/Day/Time (freely programmable)	Month/Week/Day/Time (freely programmable)
NONE	None	None

4. MENU - OVERVIEW

main screen

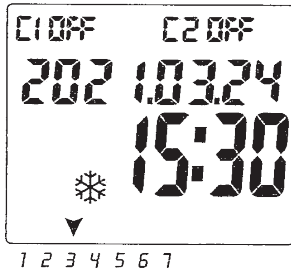

1 PROG (Programs)

Number of free programs

- Selection of no. of programs
- Selection of channel (only dual-channel)
- Choice of day / groups of days (only weekly mod.)
- TIME Program ON (start-up) data entry
- TIME Program OFF (switch-off) data entry

2 ERASE PG (Program deletion)

- Deleting a single program
- Deleting all the programs

3 HOLIDAY

Number of free programs

- Selection of no. of programs
- Selection of channel (only dual-channel)
- Setting – MONTH – DAY OFF
- Setting – MONTH – DAY ON

4 OVERRIDE (relay override)

- Selection of channel (only dual-channel)
- AUTO
- ON PERM permanent manual
- OFF PERM permanent manual
- ON TEMP temporary manual
- OFF TEMP temporary manual

5 OPTION

- Language selection
- TIME settings
- Maintenance
- Hour counter
- LED light (back-lighting)
- Warranty
- Info

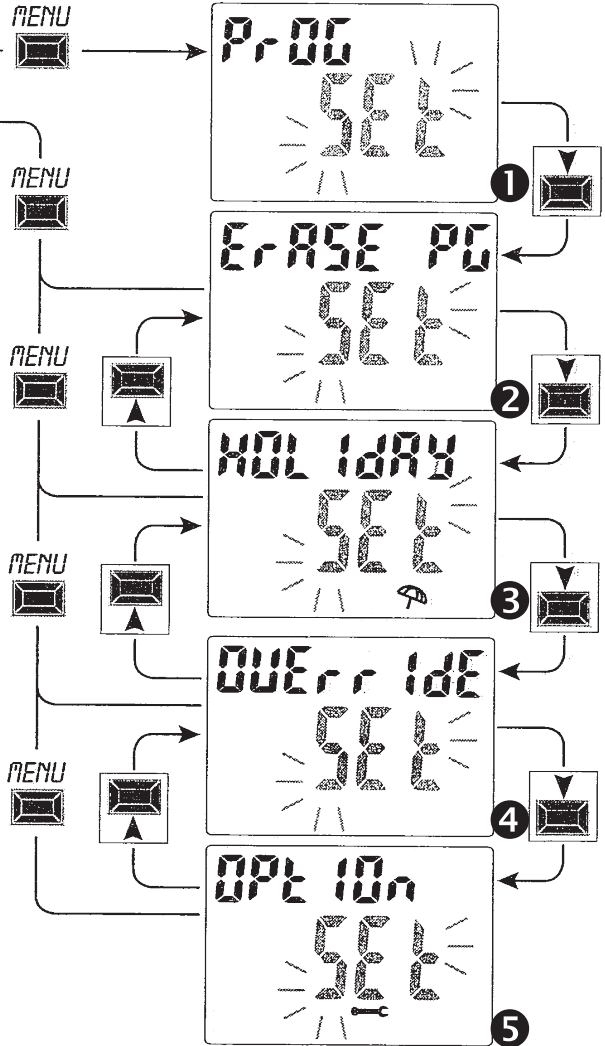

How to select the desired menu:

1. Press the **MENU** key. The first selectable menu appears.
2. Scroll through the various menus using the keys  $\uparrow$ / $\downarrow$ .
3. Confirm the desired menu with **OK**: the sub-menus and settings are accessed.

Exit or return to the previous menu or setting by pressing the **MENU** pulse key or keep it pressed to return to the main screen.

### 5. <PROG > MENU (PROGRAMS)

This menu allows you to create, test, modify and delete the TIME programs.

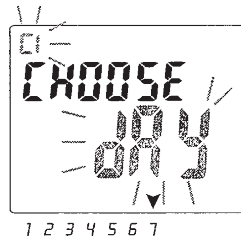
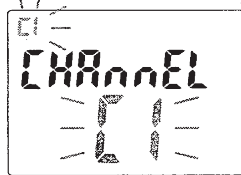
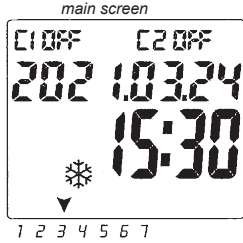

continue

#### CREATING A NEW TIME PROGRAM

1. Press the **MENU** key to access the first menu (**PROG SET**). Confirm with **OK**.  
The number of free programs will be displayed for about 2 seconds, then the first free program available (example: **P09**) will appear flashing.

2. Select the desired program using the  $\uparrow\downarrow$  keys. Confirm the **OK**.

- If there are several stored programs, keep the  $\uparrow$  key pressed for 2 seconds to display the first free program that is to be set.
- Press the keys  $\uparrow\downarrow$  simultaneously for 2 seconds to rapidly delete the selected program.

If **Holiday** programs are saved, they are not displayed in this menu.

3. Use  $\uparrow\downarrow$  keys to select channel C1 or C2 or both (only for the dual-channel model). Confirm with **OK**.

#### Only for Weekly models:

4. Use the  $\uparrow\downarrow$  keys to select the day or groups of days when the program must start (default:1=Monday). Selected the day or groups of days, arrow/s indicate the one/s chosen (example in the figure on the side: 7=Sunday) Confirm with **OK**.

DAY OR GROUPS OF DAYS TABLE (weekly mod. only)		
$\nabla$ 1 2 3 4 5 6 7	Monday	$\nabla\nabla\nabla\nabla\nabla\nabla\nabla$ 1 2 3 4 5 6 7 from Monday to Saturday
$\nabla$ 1 2 3 4 5 6 7	Tuesday	$\nabla\nabla\nabla\nabla$ 1 2 3 4 5 6 7 from Monday to Friday
$\nabla$ 1 2 3 4 5 6 7	Wednesday	$\nabla\nabla$ 1 2 3 4 5 6 7 Saturday and Sunday
$\nabla$ 1 2 3 4 5 6 7	Thursday	$\nabla\nabla\nabla\nabla\nabla\nabla\nabla$ 1 2 3 4 5 6 7 Every day
$\nabla$ 1 2 3 4 5 6 7	Friday	
$\nabla$ 1 2 3 4 5 6 7	Saturday	
$\nabla$ 1 2 3 4 5 6 7	Sunday	

TIME ON program:

5. Use the ↑↓ keys to enter the start-up time ON (default 00). Confirm with **OK**.
6. Use the ↑↓ keys to enter the minutes (default 00). Confirm with **OK**.
7. Use the ↑↓ keys to enter the seconds (default 00). Confirm with **OK**.

TIME OFF program:

8. Use the ↑↓ keys to enter the OFF time. Confirm with **OK**.
9. Use the ↑↓ keys to enter the minutes. Confirm with **OK**.
10. Use the ↑↓ keys to enter the seconds. Confirm with **OK**.

The display first shows **OKAY** and immediately after the number of free programs left and then the first free program available. Set a new program or press the **MENU** key to exit. The display shows the main screen (normal operation)

**Attention:** the programming of **TIME ON** and **TIME OFF** cannot be if they are the same, by pressing **OK** the display shows for a few seconds the message **Err** the device proposes **TIME OFF** to be modified.

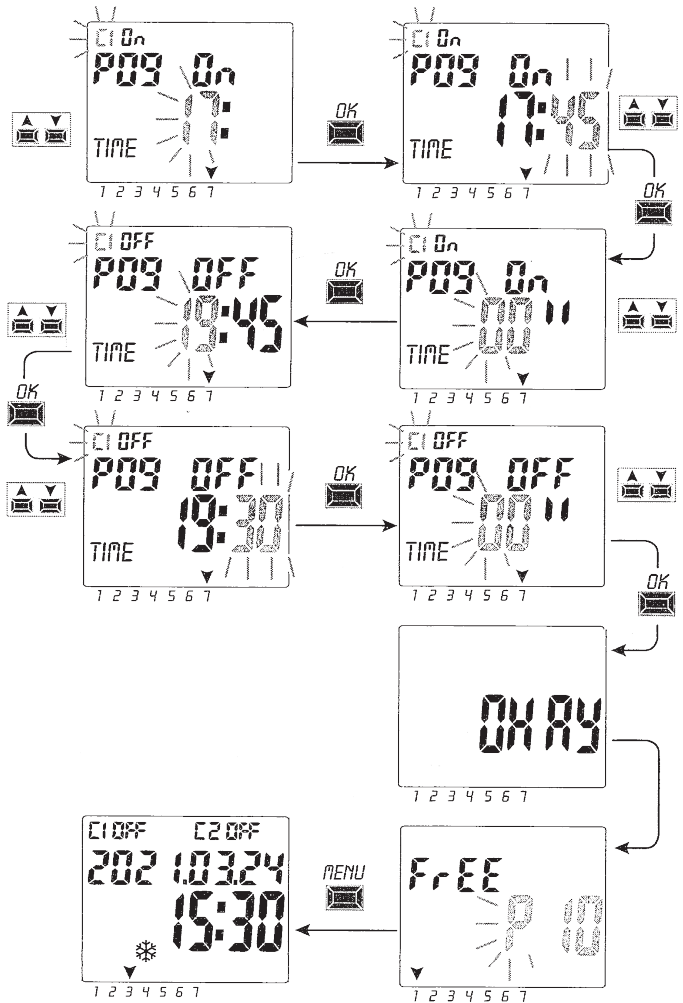

**Example:** P09 TIME program of channel 1 (C1)  
 day 7 (Sunday) switch-on ON at 17:30 – switch-off OFF at 19:30

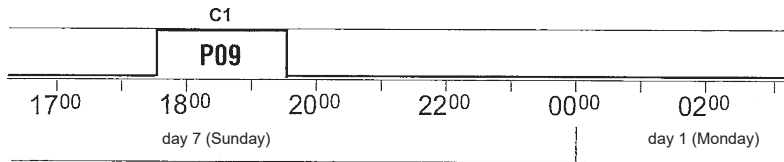

**VISUALIZING OR MODIFYING A TIME PROGRAM ALREADY SAVED**

You can view or edit a previously saved program, as already described in paragraph 5.

## 6. FORCING AND PROGRAM PRIORITY

A priority is assigned for each type of program/function as show on the right. The output relay/s will be activated according to the set priorities.

**IMPORTANT:** all programs (TIME) entered are simultaneously active regardless of their position; in the case of overlapping commands on the same output, this is activated or remains enabled On if at least one program is commanding it. (OR LOGIC)

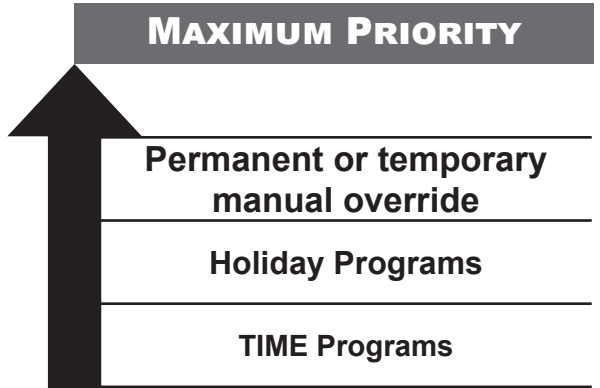

### 6.1. PROGRAMMING EXAMPLE DAILY MODEL

- P01=C1: ON at h 06:05, OFF at h 08:30.
- P02=C1: ON at h 15:00, OFF at h 21:00.
- P03=C1: ON at h 12:00, for 6 seconds.
- P04=C1: ON at h 23:00, OFF at h 06:00 of the next day
- P05=C1: ON at h 10:00, OFF at h 11:00

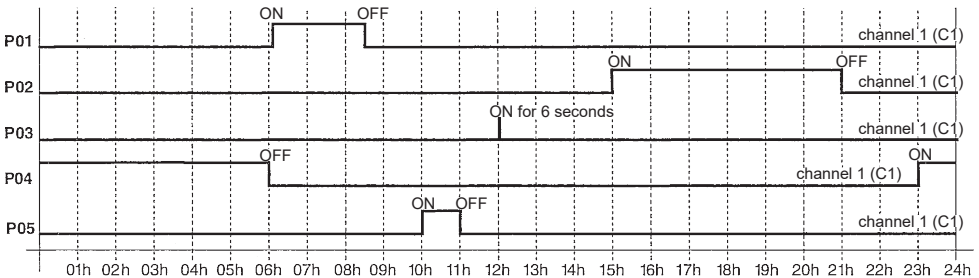

### 6.2. PROGRAMMING EXAMPLE WEEKLY MODEL

- P01=C1: from Monday to Friday, ON from h 06:05, OFF at h 08:30
- P02=C2: from Monday to Friday, ON from h 15:00, OFF at h 21:00.
- P03=C1+C2: ON from h 18:00 on Friday, OFF at h 21:00 on Sunday.
- P04=C1: from Monday to Thursday ON at h 12:00 for 6 sec.
- P05=C1+C2: ON from h 23:00 on Monday, OFF at h 06:00 on Tuesday.

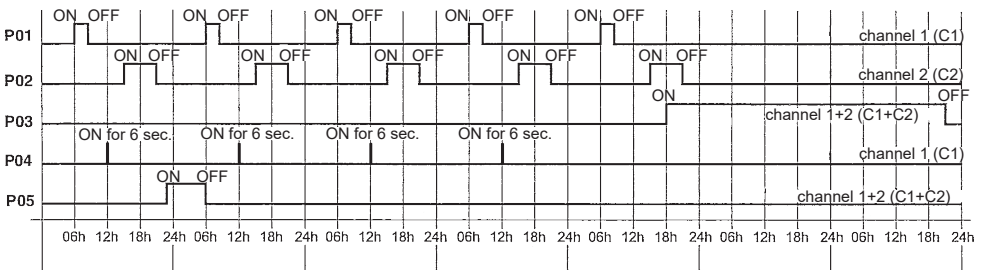

## **IMPORTANT INFORMATIONS ABOUT THE TIME SWITCHES**

The controllers are made with several types of time switches, and if the type is different from the one in this manual, you should download Time switches manual from the manufacturer's website or request it from your distributor or service centre.

For multi-channel time switch, only the first channel is used (C1), nothing is connected to the second channel, it is not worth programming them.

The controllers which using the Perry time switch must be powered for 24 hours to charge the program clock battery.

Controllers must be kept powered continuously because the time switch' battery can only last a few hours without power, and without power for several weeks or months, the battery will permanently die and no adjustments can be made.

If the controller forgets the settings, the exact time or starts randomly switching on the heating after only a few minutes or a few hours of power failure, it is likely that the battery is dead. In such a case, contact the service or retailer from whom you bought the appliance, as the battery can only be replaced and the settings reset by the manufacturer of the regulator.

The time switch run on battery power and are also used to bridge power outages. These batteries have a lifespan of approx. 4-6 years. After this time, you will need to replace either the entire time switch or the inner battery, otherwise the time switch will not work. Batteries are considered hazardous waste and must be stored in a separate container.

If you have a technical error or question, please contact the your distributor.

## 10. WARRANTY AND SERVICES

### Preserve this warranty card

Type: \_\_\_\_\_

Serial no.: \_\_\_\_\_

Date of purchasing: \_\_\_\_\_

#### LIMITED GUARANTEE \*

The manufacturer guarantee the costumer that the product and its parts are free from material and production fails. During normal use the warranty is 1 year. This warranty concerns the first retail customer.

The guarantee concerns the costs of laboratory investigations and the parts, which are needed for proper operation. The delivery and unforeseeable costs belong also to the mending costs and do not contain compensation costs.

Guarantee mending can only be realized by authorized retailer or service centre.

The guarantee does not concerns the following fails, which are caused by: improper using, damaging, neglect, accident, lack of maintenance, normal attrition, transformation, modification and operation influence factor, contaminated fuel, installation of non-suitable part and mending which is done by not authorized retailer or service station.

The regular maintenance is the owner's responsibility.

The manufacturer does not assume the responsibility in case of accidentally happened or directly caused mistake respectively improper using.

**\*We reserve the right to change of this specification without extra notification. The guarantee can be applied in accordance with above defined. Additional guarantee is not accepted.**

#### Guarantee servicing

If your appliance needs guarantee service in that case it can be requested at nearest authorized service station giving in the appliance for repairs. This service is included with the purchase agreement.

#### Mending services

Take the appliance to the nearest authorized service station. If the device is not under guarantee the service cost will be invoiced to the costumer at defined price. The service centres are independent from one another and may have different owners. We reserve the right to change of this specification without extra notification. If you would like to contact us the type and serial number of device always be at hand.

**In case of other needed information write to distributor.**

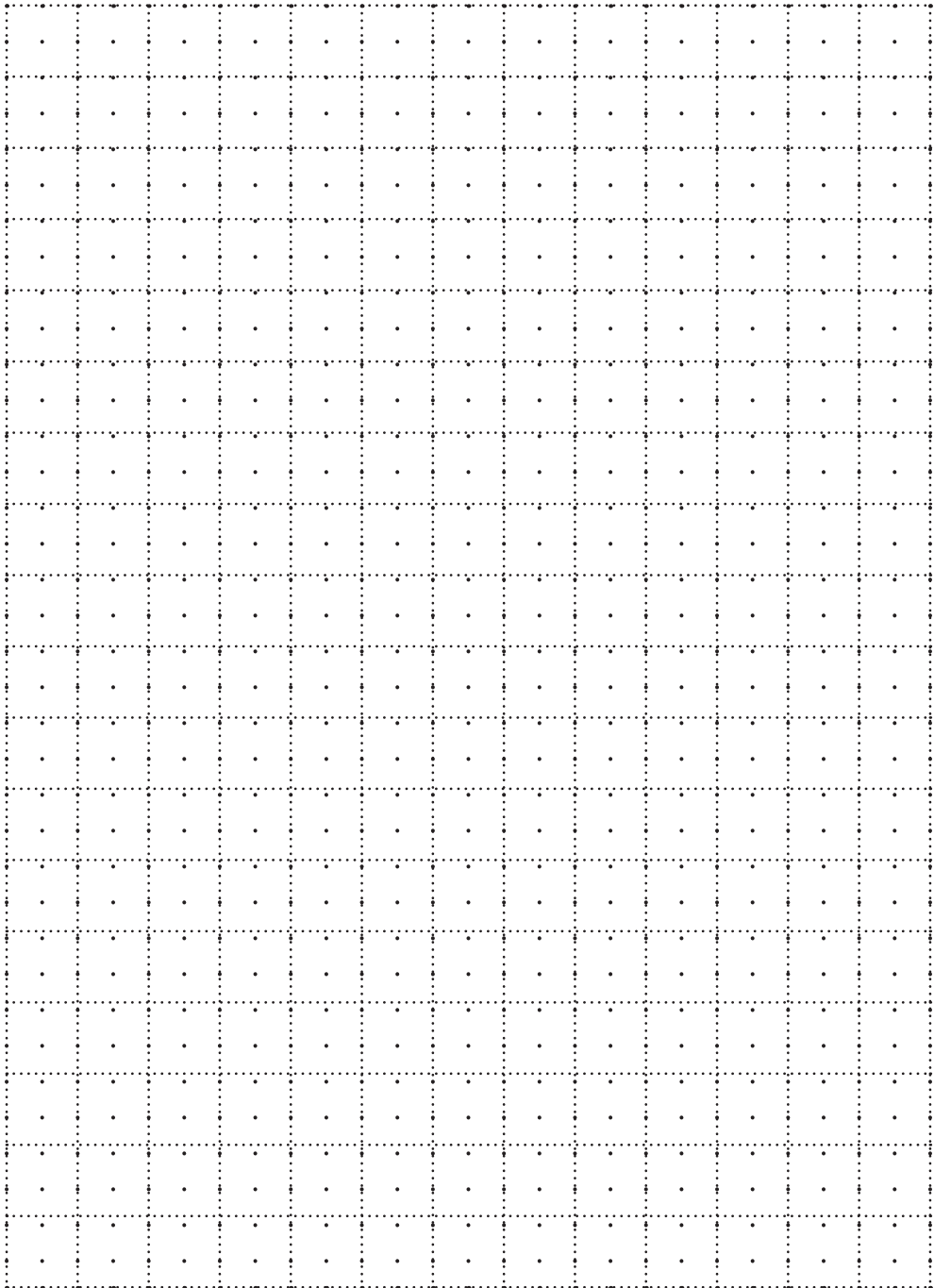

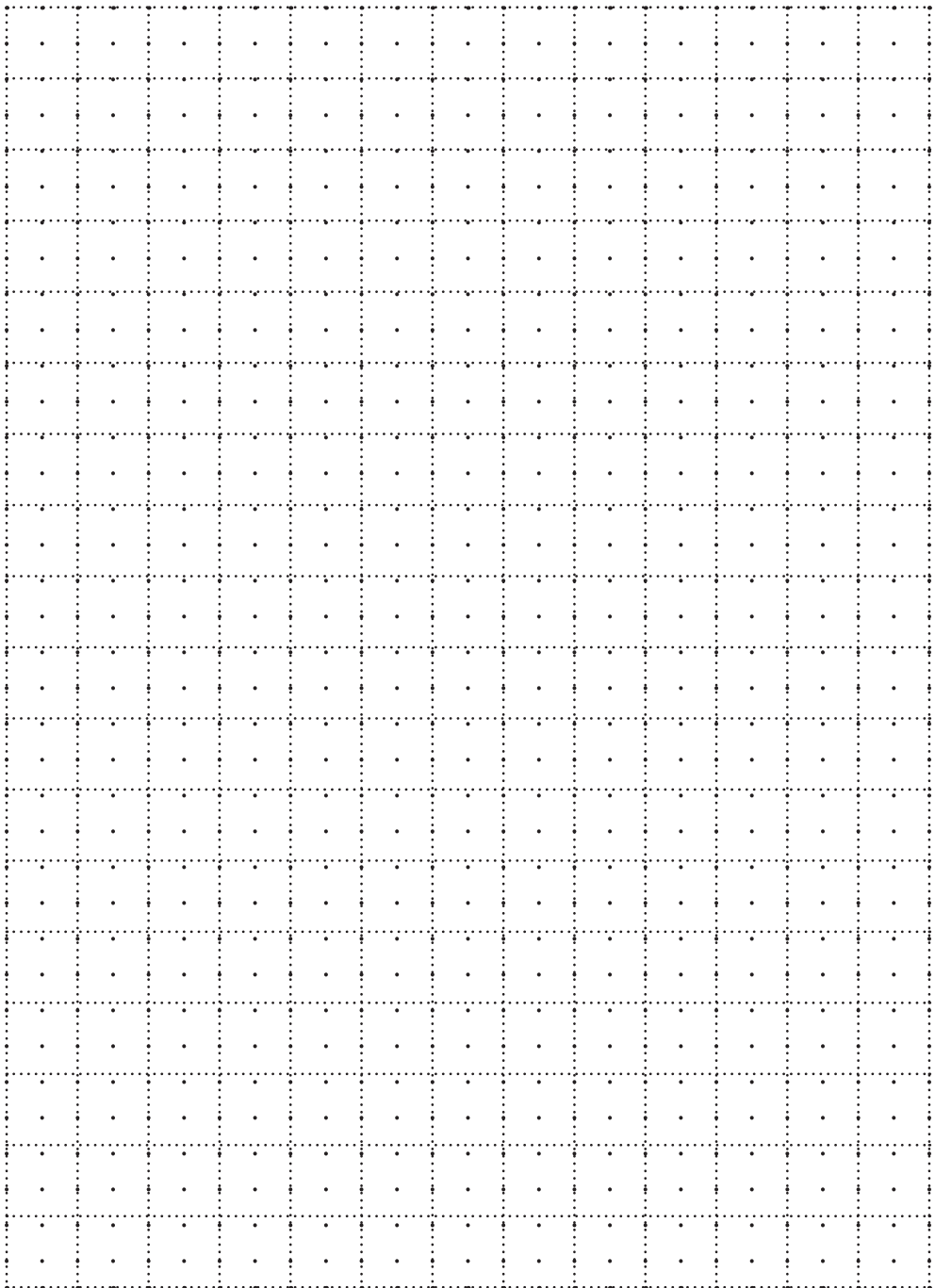



**PAKOLE**

[www.pakole.com](http://www.pakole.com)

---

**PAKOLE TRADE Ltd.**

H-8000 Székesfehérvár, Börgöndi út 8-10.

[www.pakole.com](http://www.pakole.com)

[mail@pakole.hu](mailto:mail@pakole.hu)

Tel.: +36 22 316 484